

la douche
RECEVEURS DE DOUCHE

STUDIO PLUS



STUDIO PLUS 70x150 blanc, finition texture lisse



STUDIO PLUS

la douche
RECEVEURS DE DOUCHE



STUDIO PLUS 70x150 blanc, finition texture lisse



STUDIO PLUS 70x150 blanc, finition texture lisse



HAUTEUR



40 mm

INSTALLATION



A poser



Encastré

CACHE BONDE ET BONDES

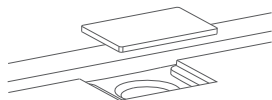

Inclus cache bonde de Scene®
pour évacuation

Inclus bonde Ø90 (UNE EN-274)
Possibilité d'installation avec
une autre bonde de Ø90

FINITION SUPERFICIELLE



Finition texture lisse

Traitement Antislip Classe 3 (ENV 12633) | C (DIN 51097) | PN24 (XP P05-011), optionnel

MATERIAU ET COULEUR

Scene



BLANC

STUDIO PLUS

la douche
RECEVEURS DE DOUCHE
tarif

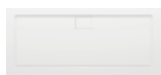

Rectangulaire



		STUDIO PLUS	
		Scene	
		COULEUR BLANC	
		texture lisse	
		<input type="checkbox"/>	
70	120-130		SSTC 0001
	131-140		SSTC 0002
	150-160		SSTC 0003
	161-170		SSTC 0004
	171-180		SSTC 0005
	181-190		SSTC 0006
71-75	120-130		SSTC 0007
	131-140		SSTC 0008
	150-160		SSTC 0009
	161-170		SSTC 0010
	171-180		SSTC 0011
	181-190		SSTC 0012
76-80	120-130		SSTC 0013
	131-140		SSTC 0014
	150-160		SSTC 0015
	161-170		SSTC 0016
	171-180		SSTC 0017
	181-190		SSTC 0018

STUDIO PLUS

code



largeur



longueur

matériau

□ Scene®

couleur

□ blanc

texture

□ lisse

forme

□ rectangulaire

↳ CACHE BONDE



inclus Cache bonde pour évacuation rectangulaire en Scene®

↳ BONDES

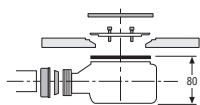

inclus Bonde sortie horizontale Viega 90 Tempoplex
Selon la norme EN-274

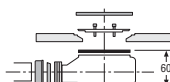

Bonde sortie horizontale Viega 90 Tempoplex Extraplate

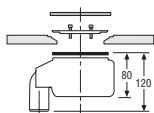

Bonde sortie verticale Viega 90 Tempoplex
Selon la norme EN-274

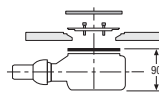

Bonde sortie horizontale Viega 90 Tempoplex Plus

↳ TRAITEMENT ANTISLIP

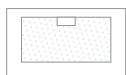

Traitement Antislip Classe 3 ENV 12633 |
C (DIN 51097) | PN24 (XP P05-011), pour Scene®

↳ DECOUPE



inclus Découpe longitudinale sur longueur et largeur cm a cm



Découpes spéciales cm a cm
Les commandes seront confirmées sur plan



STUDIO PLUS

la douche
RECEVEURS DE DOUCHE
information technique



STUDIO PLUS 70x150 blanc, finition texture lisse

PLATO DE DUCHA STUDIO PLUS / STUDIO PLUS SHOWER TRAY / RECEVEUR DE DOUCHE STUDIO PLUS / BASE DE CHUVEIRO STUDIO PLUS

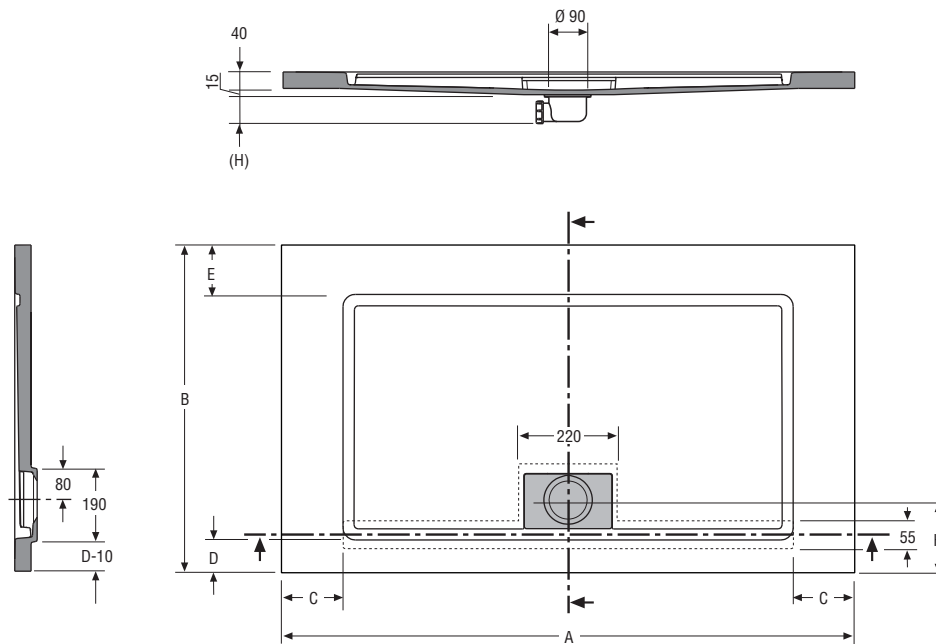
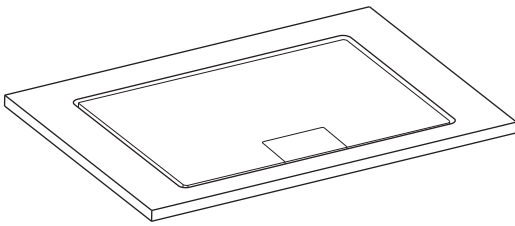

A	B	C	D	E	H	V	P
1200	700	50	50	50	148	0'124	66
1210 → 1300	700	100	50	50	148	0'124	68
1310 → 1400	700	150	50	50	148	0'132	74
1500 → 1600	700	100	50	50	148	0'150	79
1610 → 1700	700	150	50	50	148	0'158	85
1710 → 1800	700	100	50	50	148	0'167	92
1810 → 1900	700	150	50	50	148	0'176	98

A	B	C	D	E	H	V	P
1200	750	50	80	70	178	0'124	70
1210 → 1300	750	100	80	70	178	0'124	72
1310 → 1400	750	150	80	70	178	0'132	79
1500 → 1600	750	100	80	70	178	0'150	87
1610 → 1700	750	150	80	70	178	0'158	94
1710 → 1800	750	100	80	70	178	0'167	98
1810 → 1900	750	150	80	70	178	0'176	105

A	B	C	D	E	H	V	P
1200	800	50	80	120	178	0'131	76
1210 → 1300	800	100	80	120	178	0'131	78
1310 → 1400	800	150	80	120	178	0'140	85
1500 → 1600	800	100	80	120	178	0'158	94
1610 → 1700	800	150	80	120	178	0'167	101
1710 → 1800	800	100	80	120	178	0'177	106
1810 → 1900	800	150	80	120	178	0'189	113

Medidas en mm / Sizes in mm / Mesures en mm/ Medidas em mm

V Volumen de expedición sin palet (m3) | Shipping volume without palet | Volume à l'expédition sans palet | Volume expedição sin palet
P Peso de expedición sin palet (Kg) | Shipping weight without palet | Poids à l'expédition sans palet | Peso de expedição sin palet

(H) Medida en función del desagüe suministrado | Height according to valve supplied | Mesure en fonction du vidage livré | Medida em função da válvula fornecida

la douche
RECEVEURS DE DOUCHE

ZONE

ZONE 90x160 blanc, finition texture lisse



ZONE

la douche
RECEVEURS DE DOUCHE



ZONE 90x140 blanc, finition texture lisse

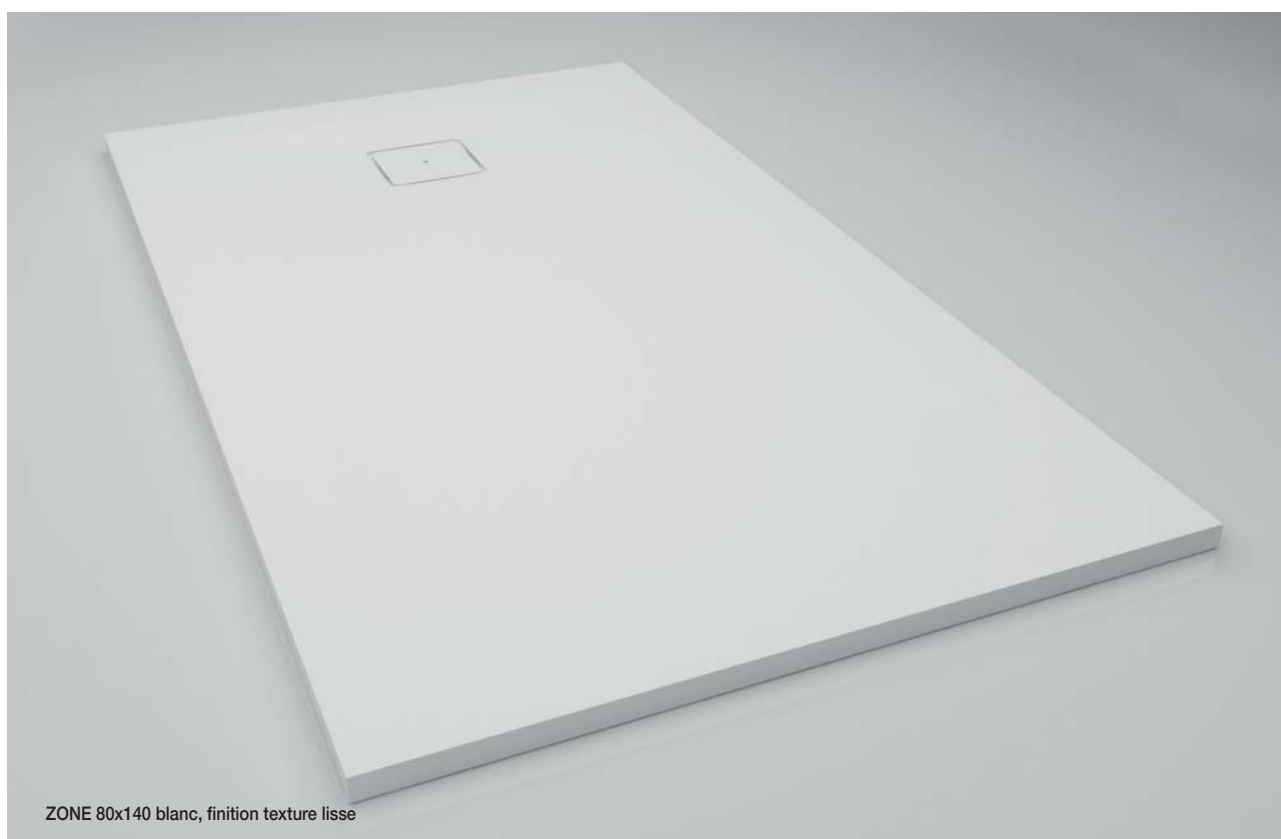

ZONE 80x140 blanc, finition texture lisse

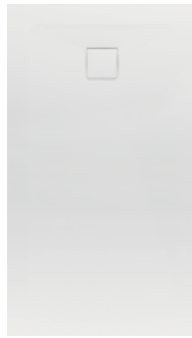

HAUTEUR



25 mm

INSTALLATION



A poser



Encastré

CACHE BONDE ET BONDES



Inclus cache bonde de Scene®
pour évacuation

Inclus bonde Ø90 (UNE EN-274)
Possibilité d'installation avec
une autre bonde de Ø90

FINITION SUPERFICIELLE



Finition texture lisse

Traitement Antislip Classe 3 (ENV 12633) | C (DIN 51097) | PN24 (XP P05-011), optionnel

MATERIAU ET COULEUR

Scene



BLANC

ZONE

la douche
RECEVEURS DE DOUCHE
tarif



Rectangulaire



		ZONE		
		Scene		
		COULEUR BLANC		
		texture lisse		
		<input type="checkbox"/>		
70	100-110		SZOC 0001	
	111-120		SZOC 0002	
	121-130		SZOC 0003	
	131-140		SZOC 0004	
	141-150		SZOC 0005	
	151-160		SZOC 0006	
	161-170		SZOC 0007	
71-75	100-110		SZOC 0008	
	111-120		SZOC 0009	
	121-130		SZOC 0010	
	131-140		SZOC 0011	
	141-150		SZOC 0012	
	151-160		SZOC 0013	
	161-170		SZOC 0014	
76-80	100-110		SZOC 0015	
	111-120		SZOC 0016	
	121-130		SZOC 0017	
	131-140		SZOC 0018	
	141-150		SZOC 0019	
	151-160		SZOC 0020	
	161-170		SZOC 0021	
80-90	120-130		SZOC 0022	
	131-140		SZOC 0023	
	91-100	120-130		SZOC 0024
		131-140		SZOC 0025



Rectangulaire C



Rectangulaire R		ZONE	
		Scene	
		COULEUR BLANC	
		texture lisse	
90-100	100-110	SZOC 0026	
	111-120	SZOC 0027	
Rectangulaire L			
90-100	100-110	SZOC 0028	
	111-120	SZOC 0029	

ZONE

code

largeur x longueur

materiu Scene®

couleur blanc

texture lisse

forme rectangulaire
 rectangulaire C
 rectangulaire R
 rectangulaire L

↳ CACHE BONDE

inclus Cache bonde pour évacuation rectangulaire en Scene®

↳ BONDES

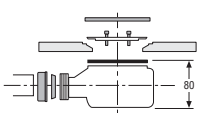
 **inclus** Bonde sortie horizontale Viega 90 Tempoplex
Selon la norme EN-274

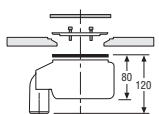
 Bonde sortie verticale Viega 90 Tempoplex
Selon la norme EN-274

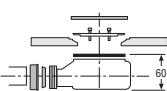
 Bonde sortie horizontale Viega 90 Tempoplex Extraplate

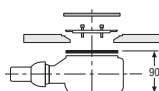



 Bonde sortie horizontale Viega 90 Tempoplex Plus

↳ TRAITEMENT ANTISLIP

Traitement Antislip Classe 3 ENV 12633 |
C (DIN 51097) | PN24 (XP P05-011), pour Scene®

↳ DECOUPE SPECIALE

inclus Découpe longitudinal sur longueur et largeur cm a cm

   Découpes spéciales cm a cm
Les commandes seront confirmées sur plan 

ZONE

la douche
RECEVEURS DE DOUCHE
information technique

PLATO DE DUCHA ZONE RECTANGULAR / ZONE RECTANGULAR SHOWER TRAY / RECEVEUR DE DOUCHE ZONE RECTANGULAIRE / BASE DE CHUVEIRO ZONE RETANGULAR

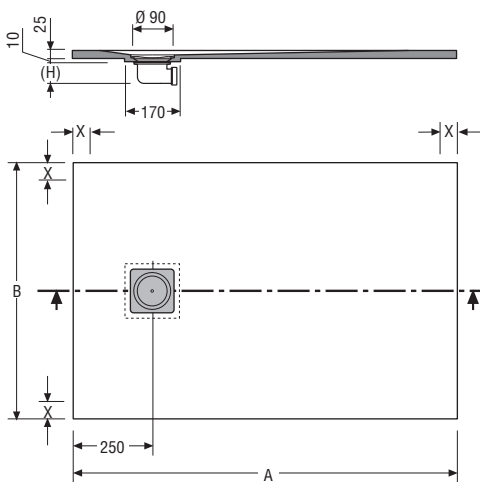
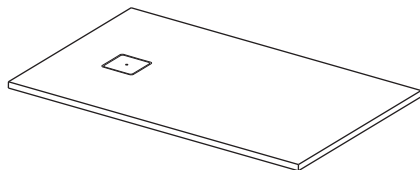

A	B	V	P	A	B	V	P	A	B	V	P
1000	700	0'063	31	1000	750	0'063	33	1000	800	0'063	36
1010 → 1100	700	0'071	35	1010 → 1100	750	0'071	37	1010 → 1100	800	0'071	40
1110 → 1200	700	0'075	38	1110 → 1200	750	0'075	41	1110 → 1200	800	0'075	44
1210 → 1300	700	0'083	41	1210 → 1300	750	0'083	44	1210 → 1300	800	0'083	47
1310 → 1400	700	0'087	44	1310 → 1400	750	0'087	48	1310 → 1400	800	0'087	51
1410 → 1500	700	0'094	47	1410 → 1500	750	0'094	51	1410 → 1500	800	0'094	54
1510 → 1600	700	0'102	51	1510 → 1600	750	0'102	55	1510 → 1600	800	0'102	59
1610 → 1700	700	0'106	54	1610 → 1700	750	0'106	58	1610 → 1700	750	0'106	62

Medidas en mm / Sizes in mm / Mesures en mm/ Medidas em mm

V Volumen de expedición sin palet (m3) | Shipping volume without palet | Volume à l'expédition sans palet | Volume expedição sin palet
P Peso de expedición sin palet (Kg) | Shipping weight without palet | Poids à l'expédition sans palet | Peso de expedição sin palet
X Zona emplazamiento mampara. El espacio mínimo reservado para la mampara es de 30 mm | Glass enclosure zone. The minimum area reserved for the glass enclosure is 30 mm | Zone d'emplacement de la paroi de douche | L'espace minimum réservé à la paroi est de 30 mm | Zona de colocação da divisória. O espaço mínimo necessário à divisória é de 30 mm
(H) Medida en función del desagüe suministrado | Height according to valve supplied | Mesure en fonction du vidage livré | Medida em função da válvula fornecida

PLATO DE DUCHA ZONE RECTANGULAR C / ZONE RECTANGULAR C SHOWER TRAY / RECEVEUR DE DOUCHE ZONE RECTANGULAIRE C / BASE DE CHUVEIRO ZONE RETANGULAR C

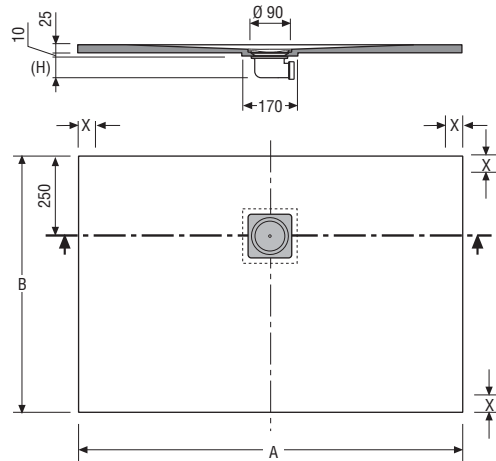
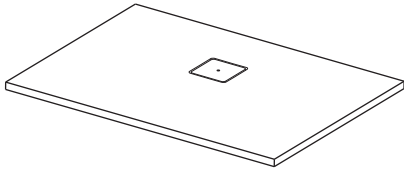

A	B	V	P
1200	900	0'094	49
1210 - 1300	900	0'104	54
1310 - 1400	900	0'109	59
1200	1000	0'094	55
1210 - 1300	1000	0'104	61
1310 - 1400	1000	0'109	66

Medidas en mm / Sizes in mm /
Mesures en mm / Medidas em mm

PLATO DE DUCHA ZONE RECTANGULAR L/R / ZONE RECTANGULAR L/R SHOWER TRAY / RECEVEUR DE DOUCHE ZONE RECTANGULAIRE L/R / BASE DE CHUVEIRO ZONE RETANGULAR L/R

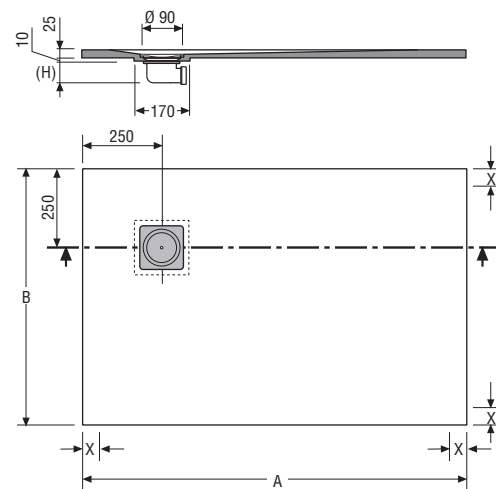
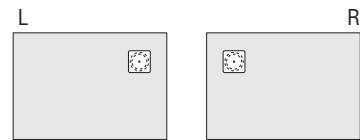
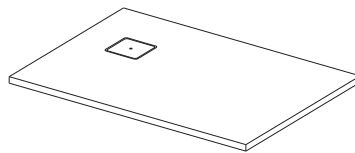
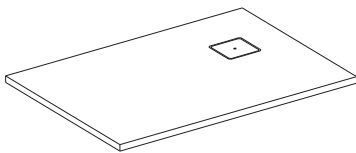

A	B	V	P
1000	900	0'079	41
1010 - 1100	900	0'089	46
1110 - 1200	900	0'094	51
1000	1000	0'079	45
1010 - 1100	1000	0'089	50
1110 - 1200	1000	0'094	55

Medidas en mm / Sizes in mm /
Mesures en mm / Medidas em mm

V Volumen de expedición sin palet (m3) | Shipping volume without palet | Volume à l'expédition sans palet | Volume expedição sin palet
P Peso de expedición sin palet (Kg) | Shipping weight without palet | Poids à l'expédition sans palet | Peso de expedição sin palet
X Zona emplazamiento mampara. El espacio mínimo reservado para la mampara es de 30 mm | Glass enclosure zone. The minimum area reserved for the glass enclosure is 30 mm | Zone d'emplacement de la paroi de douche | L'espace minimum réservé à la paroi est de 30 mm | Zona de colocação da divisória. O espaço mínimo necessário à divisória é de 30 mm
(H) Medida en función del desagüe suministrado | Height according to valve supplied | Mesure en fonction du vidage livré | Medida em função da válvula fornecida